

**HAPPY BIRTHDAY**

# Paper airplane

Let your birthday wishes take flight!

\*Kids, ask a parent to help.

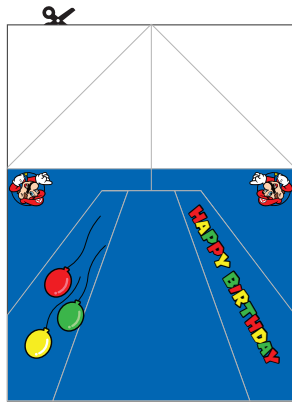

**STEP 1:** Cut out the paper rectangle along the dotted lines.

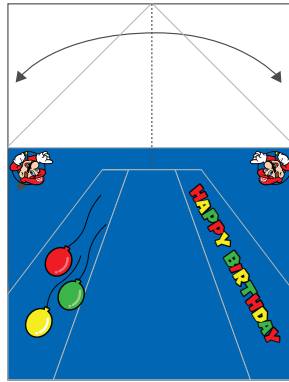

**STEP 2:** Fold the paper in half lengthwise toward the blank side.

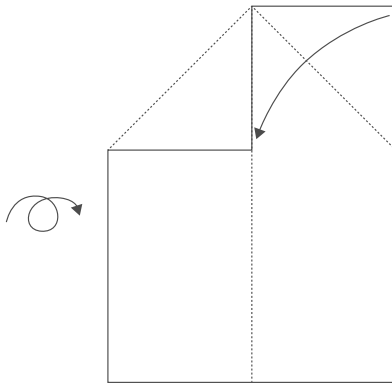

**STEP 3:** Unfold paper, then fold upper corners towards you along the solid lines.

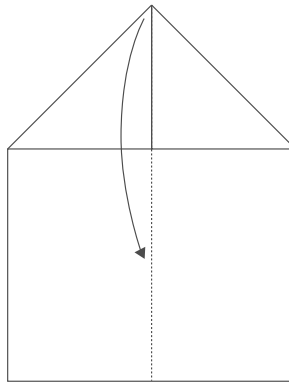

**STEP 4:** Fold top flap toward you along red border.

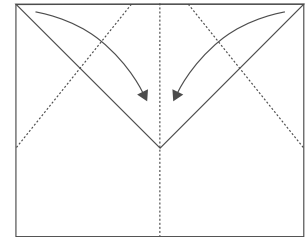

**STEP 5:** Fold both Mario flaps toward you along the solid lines, then fold the top of color side paper toward you.

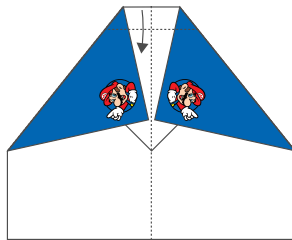

**STEP 6:** Turn over, then fold lengthwise so that color sides are facing.

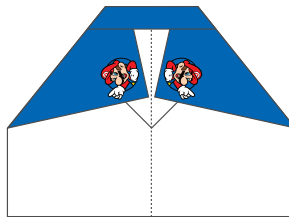

**STEP 7:** Fold top flap toward you along red border.

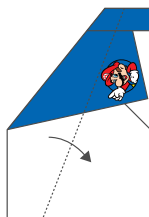
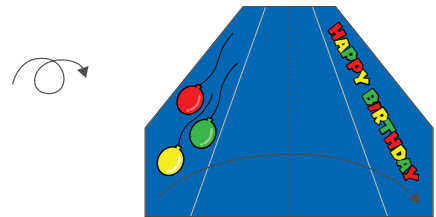

**STEP 8:** Fold on each side along the solid lines to form the wings.

